

Sanitas Troesch

Art-Nr.: 6545911

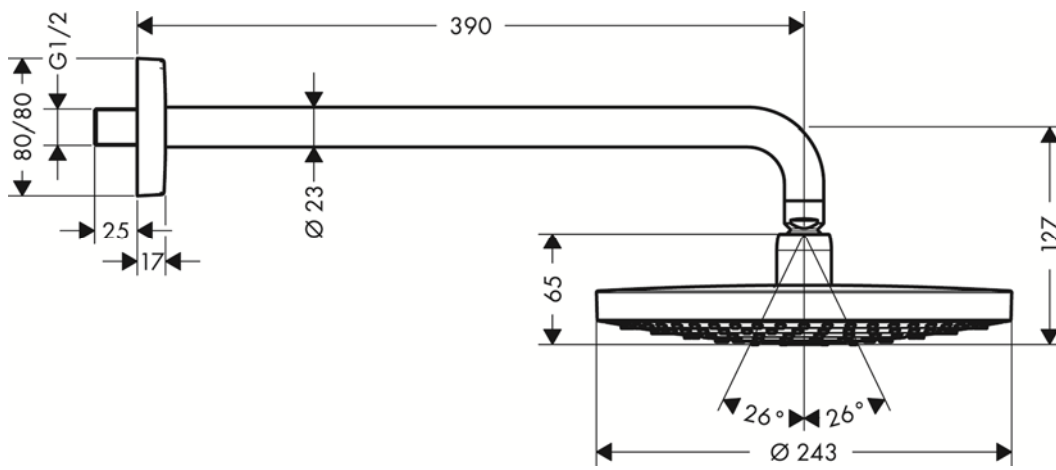

09.01.2014