

	LOW 90/2/FL
<b>EVG</b>	<b>1 x 21W, G5</b>
<b>A</b>	90
<b>B</b>	42.8 (2x)
<b>C</b>	45 (2x)
<b>D</b>	89.2
<b>E</b>	8.4 x 42.1 (4x)

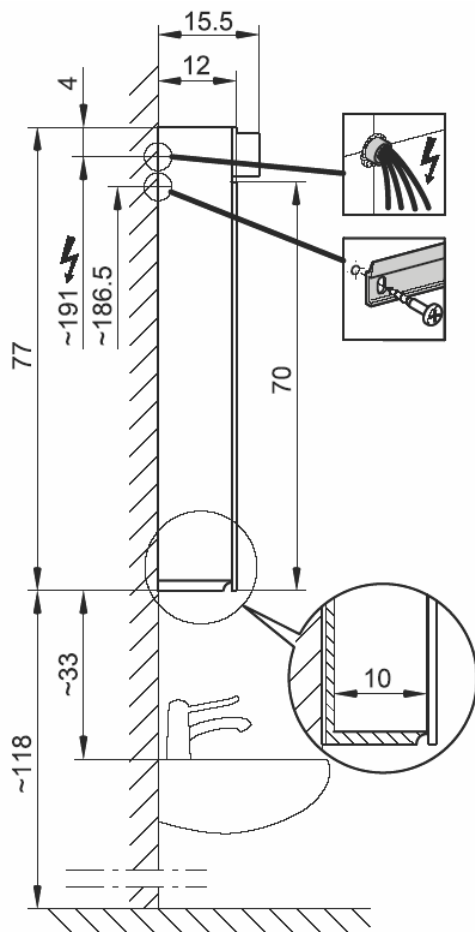

LOW/FL	A	B
90	65	12.5

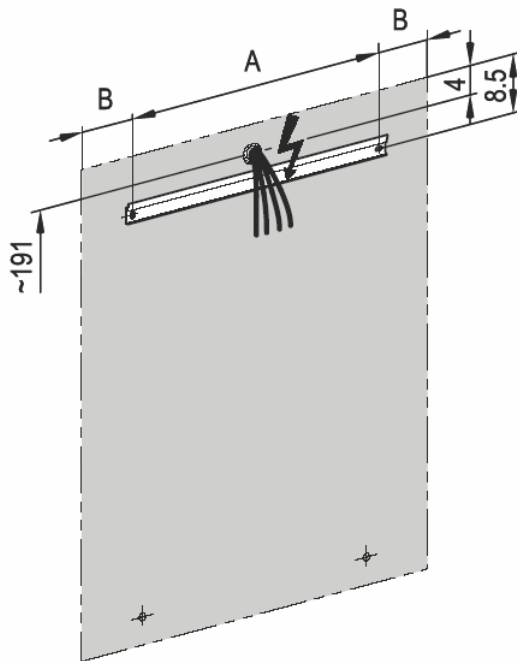

26.02.2008