

**BADEWANNE** (ohne Whirlsystem)  
Position der Armaturen und der Aggregate

**WHIRLPOOL**

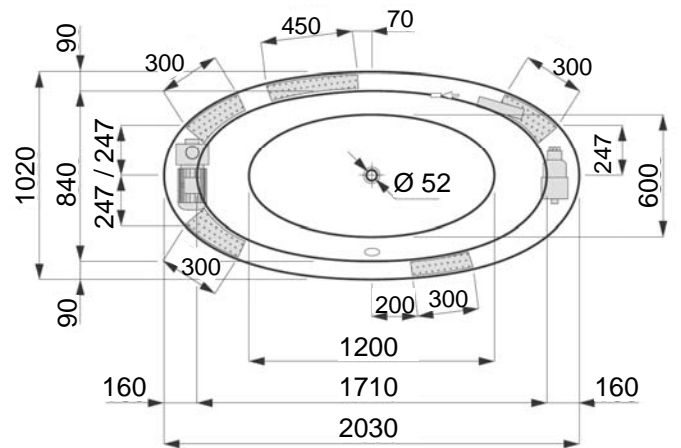
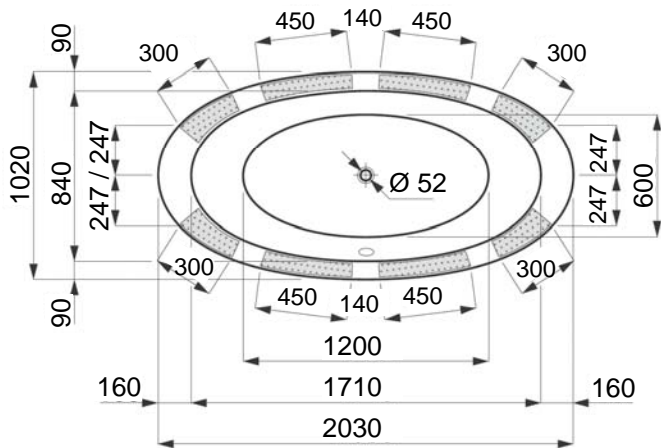

27.03.2009